

Overview

- 2MP (1920*1080)
- WDR 120dB
- 2.8 - 12mm Lens
- H.265, H.264 and MJPEG
- IR, IP67







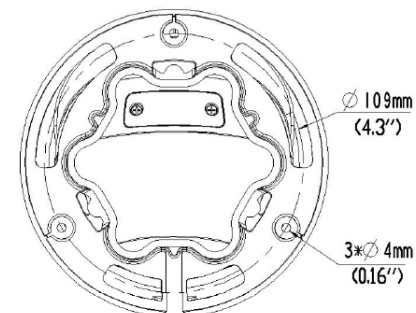
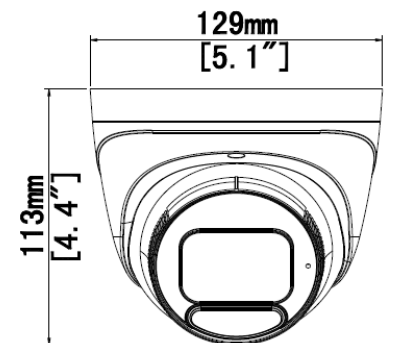











Technical Specifications

Device	
Image Sensor:	1/2.7", 2.0-megapixel, progressive scan, CMOS
Min Illumination:	Colour: 0.005Lux (F1.6, AGC ON) 0Lux with IR
Shutter Time:	Auto/Manual, 1 ~ 1/100000s
Lens:	2.8 ~ 12mm, AF automatic focusing and motorized zoom lens
WDR:	120dB
Angle of View:	H: 108.05°~ 32.59°V: 56.81°~ 18.36°, 111.91°~36.53°
Angle Adjustment:	Pan: 0° ~ 360° Tilt: 0° ~ 75° Rotate: 0° ~ 360°
3-Axis Adjustment:	Yes
Day & Night:	IR-Cut Filter with Auto Switch (ICR)
IR Range:	Up to 40m (131ft) IR range
Compression Standard	
Video Compression:	H.265, H.264, MJPEG
Video Bit Rate:	128 Kbps ~ 6 Mbps
Two Stream:	Yes
Analytics:	Cross line, intrusion (based on human body detection) motion detection, tampering alarm, audio detection
Image	
Max. Image Resolution:	1920 x 1080
Frame Rate:	30fps (1920 x 1080)
ROI Codec:	Up to 8 areas
Image Setting:	White Balance, Digital Noise Reduction, Smart IR, Flip, HLC, BLC, Defog



Technical Specifications

Network							
Protocols:	IPv4, IGMP, ICMP, ARP, TCP, UDP, DHCP, RTP, RTSP, RTCP, RTMP, DNS, DDNS, NTP, FTP, UPnP, HTTP, HTTPS, SMTP, SSL/TLS, QoS, SNMP						
Interface							
Communication Interface:	10M/100M Base-TX Ethernet						
Built-in Microphone	Yes						
Audio							
Compression	G.711						
Storage							
Edge Storage	Micro SD, up to 128GB						
General							
Safety	CE: EN 62368-1 UL: UL 62368-1						
EMC	FCC: FCC Part 15 CE-EMC: EN 55032/ EN 55035/ EN IEC 61000-3-2/ EN 61000-3-3						
Operating Conditions:	Temperature: -30°C~60°C(-22°F~140°F), Humidity: ≤95%RH(Non-Condensing)						
Power Consumption:	Max 8.0 W						
Power Supply:	DC 12V±25%, PoE (IEEE 802.3af)						
Weatherproof Rating:	IP67						
Dimensions:	Φ129 x 113mm (Φ5.1" x 4.4")						
Net Weight:	0.66kg (1.46lb)						
Material	Metal						
Software:	No license required for use with Video Insight Software						
Optional Accessories	<table border="0"> <tr> <td style="text-align: center;">M-JB-T </td> <td style="text-align: center;">M-WM-T </td> <td style="text-align: center;">M-NPT34 </td> </tr> <tr> <td style="text-align: center;">M-PM </td> <td style="text-align: center;">M-Pendant </td> <td style="text-align: center;">M-Pendant-Ex </td> </tr> </table>	M-JB-T 	M-WM-T 	M-NPT34 	M-PM 	M-Pendant 	M-Pendant-Ex 
M-JB-T 	M-WM-T 	M-NPT34 					
M-PM 	M-Pendant 	M-Pendant-Ex 